



Safeway Technologies Ltd.

Technology for moving forward...

STL-JBZ-OCM12 High Speed Paper Cup Making Machine

Stable Running 70-80 Pcs Each Min



Address: House# 02, Road# 2/3, Banani, Dhaka-1213, Bangladesh.
Hotline: 01730793660, 01822132851, info@safewaytech.com, www.safewaytech.com



Safeway Technologies Ltd.

Technology for moving forward...

Technical Data



Click To View Machine Video

Model	High Speed Simple Model Paper Cup Machine JBZ-OCM12	
Cup Side Welding	Copper Heater	Ultrasonic heater
Paper Cup Size	2 ~16 OZ (Mould exchangeable, Max Cup Height:136mm , Max Bottom width :76mm	
Rated Speed	70-80pcs/min (Speed affected by cup size, paper quality & thickness) 9OZ, 280GSM paper cup Stable running speed 75 pcs each min.	
Raw Material	Only one-side PE coated paper (Popular for Hot drink cups)	One or Two side PE coated Paper (Popular for Hot and Cold drink Cups)
Suitable paper weight	140-250gsm	140-350gsm
Power Source:	50/60HZ, 380V/220V (better use 380V, 3 Phase) or special Power requirement.	
Total Power	6.5 KW	7.5 KW
Total Weight	GW/NW: 1800KGS/1700KGS	
Pack Size (L*W*H)	2200*1400*1900mm(Machine Wooden Box Packing Size) 1000*750*2100MM(Counting Machine Packing Size)	
Working Air Source	No need provide Air	Air pressure:0.4Mpa; Air Out-put:0.6m ³ /minute Need to buy Air Compressor(by user)
Cup Bottom Heating	Heater Knurling	1side PE paper by heater knurling; 2side PE paper by cool device (circle water) knurling.
Cup Bottom Knurling	Heater Knurling (if use single PE coated paper)	

OEM (Show Client Company Name in Machine Panel) is welcome in our factory

Address: House# 02, Road# 2/3, Banani, Dhaka-1213, Bangladesh.
Hotline: 01730793660, 01822132851, info@safewaytech.com, www.safewaytech.com



Safeway Technologies Ltd.

Technology for moving forward...

Cup Size Range

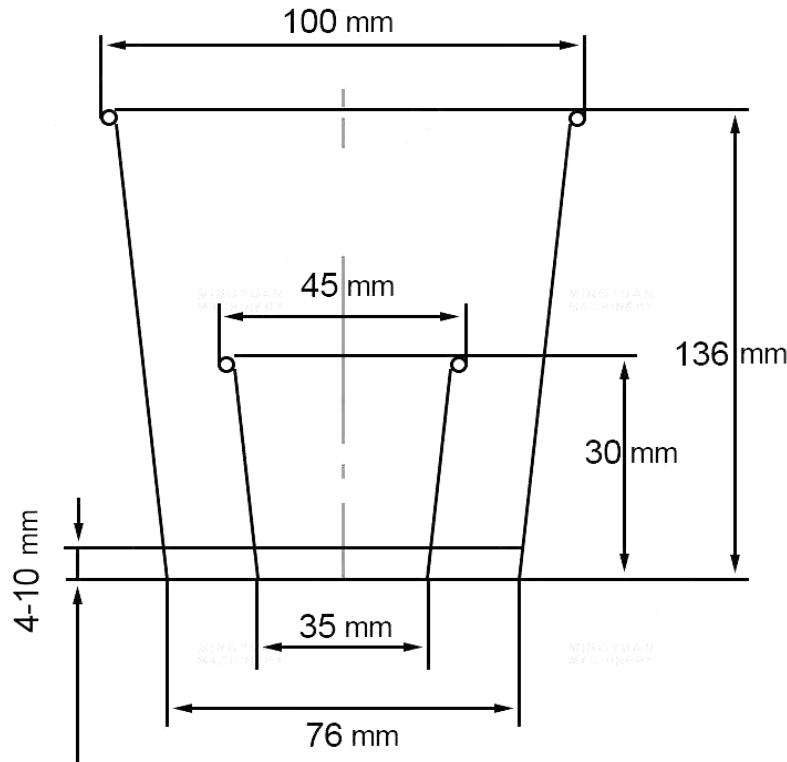

Cup Bottom Diameter:

Min 35mm ~ Max 76mm

Cup Top Diameter:

Min 45mm ~ Max 100mm;

Cup Height:

Min 30mm ~ Max 136mm

Bottom Knurling Depth:

Min 4mm ~ Max 10mm (popular 5mm)

Top Curling Rim Diameter:

Popular about $2.5\Phi \sim 3\Phi$



Safeway Technologies Ltd.

Technology for moving forward...

Machine Size

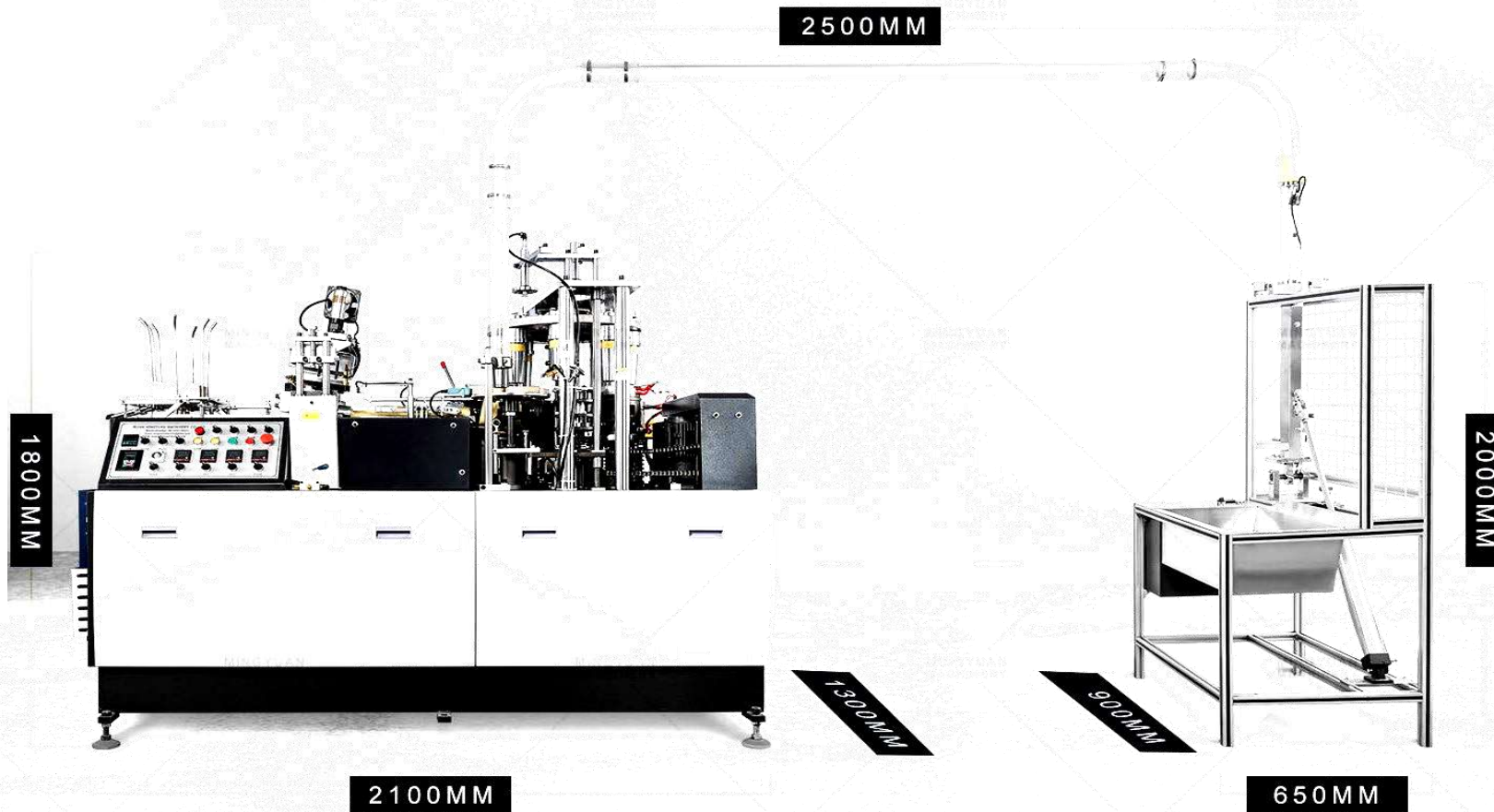

Address: House# 02, Road# 2/3, Banani, Dhaka-1213, Bangladesh.
Hotline: 01730793660, 01822132851, info@safewaytech.com, www.safewaytech.com



Safeway Technologies Ltd.

Technology for moving forward...

ULTRASONIC HEATER



COPPER HEATER



**Three
Choice**

ULTRASONIC HEATER PAPER CUP MACHINE WITH COUNTING SYSTEM

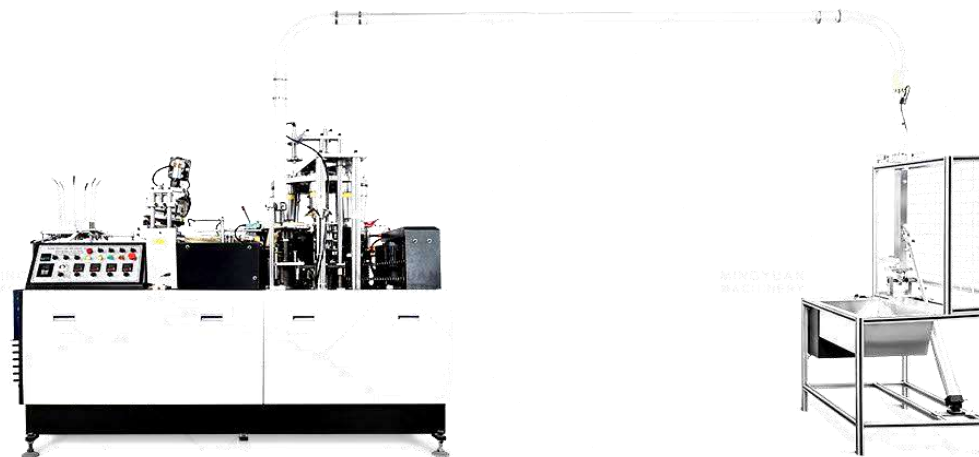



Safeway Technologies Ltd.

Technology for moving forward...

Paper Fan Heating Sealing Option

Ultrasonic heater suitable for sealing the Single PE / Double PE paper, Paper weight 140GSM-350GSM
Copper heater suitable for sealing the Single PE, Paper weight 140GSM-250GSM

ULTRASONIC HEATER

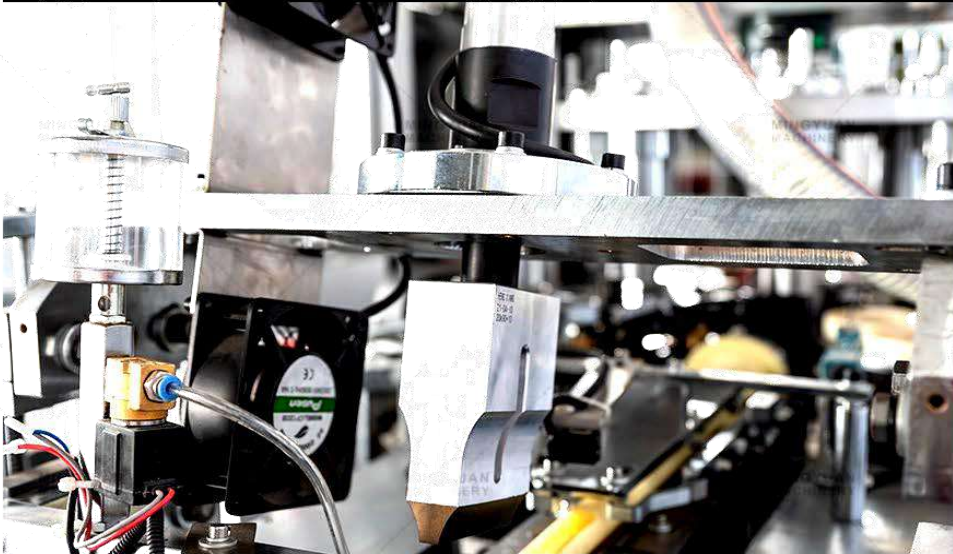

COPPER HEATER

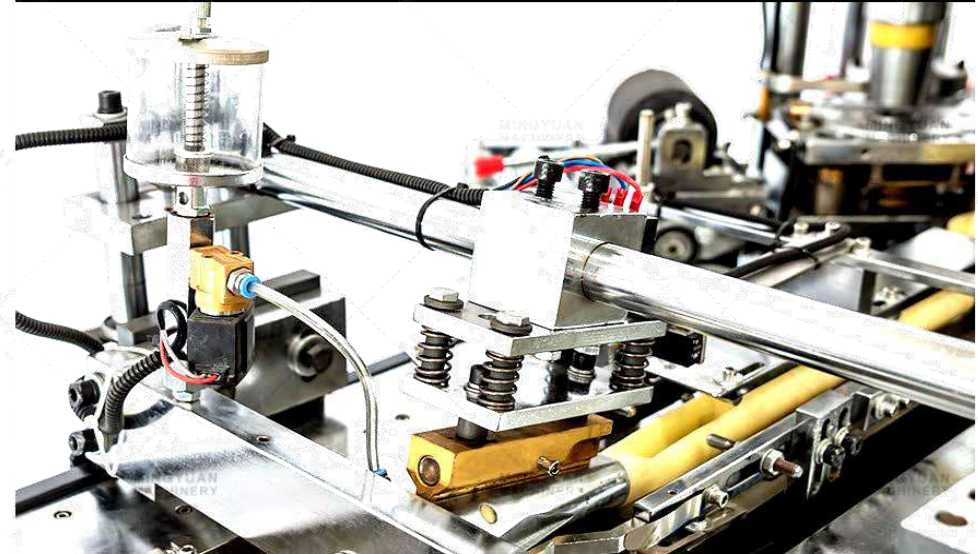



Safeway Technologies Ltd.

Technology for moving forward...

Ultrasonic Heater System

Ultrasonic heater system is with electric control box and voltage regulator which is provided for free to protect the ultrasonic electric system

ULTRASONIC ELECTRIC CONTROL BOX



VOLTAGE REGULATOR



(above spare parts are only available in ultrasonic heater machine)



Safeway Technologies Ltd.

Technology for moving forward...

Control Panel

Control panel with good quality switches, temperature controller and Speed converter. all the operation of machine can be easily finished by this panel.





Safeway Technologies Ltd.

Technology for moving forward...

Multi-function CAM

Three cams design are used to separately control the operation of the four spare parts which makes paper fan sealing more stable at high speed without troubles .

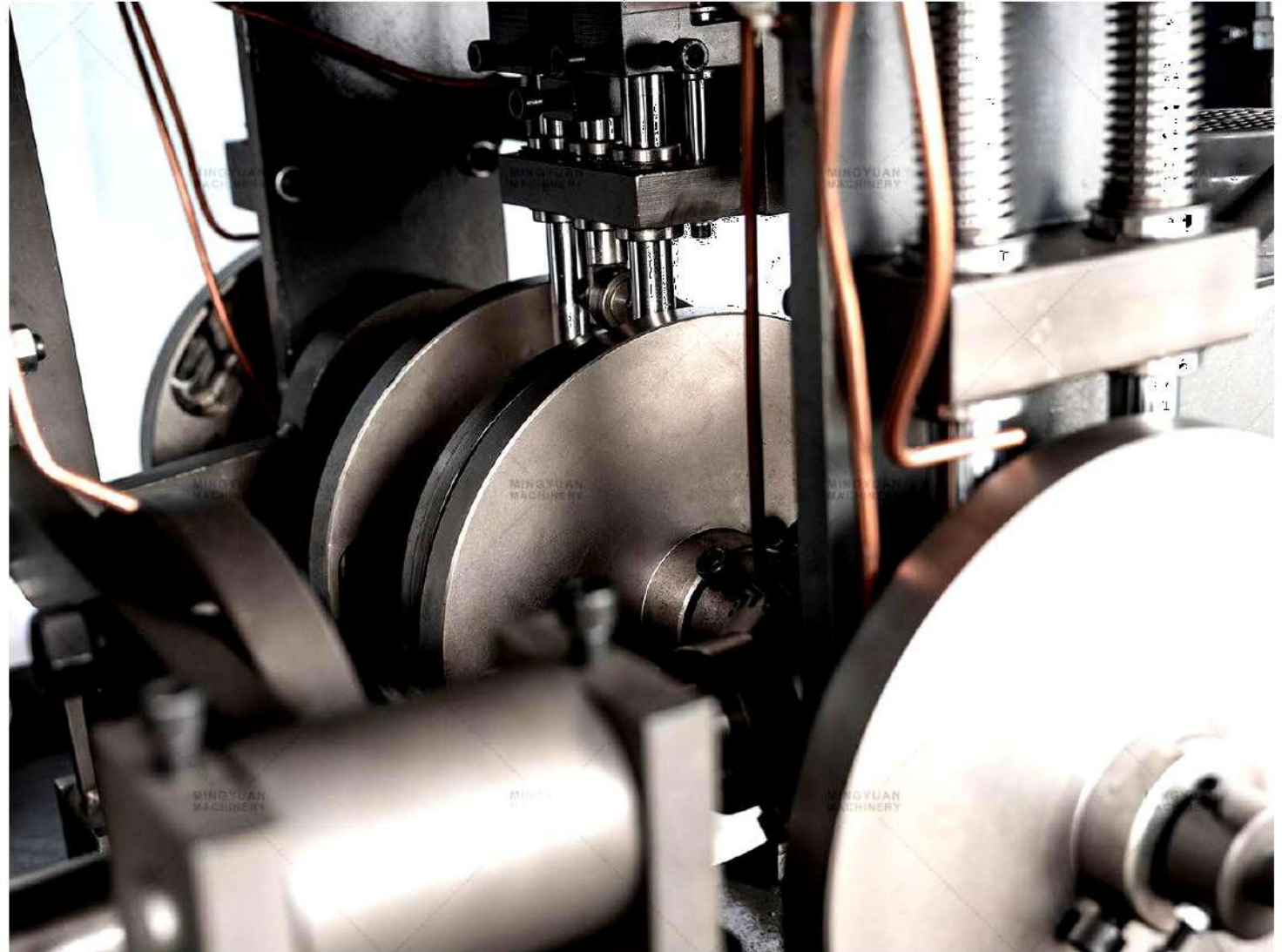



Safeway Technologies Ltd.

Technology for moving forward...

Oil Lubrication And Circulation

The whole machine adopts automatic oil lubrication system (oil circulation system is including oil motor, filter, copper pipe) which makes all gear moving parts working at high speed much more smoothly and greatly Improve the service life of spare parts .

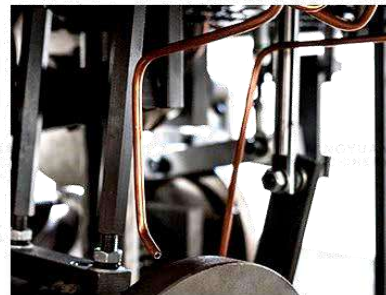
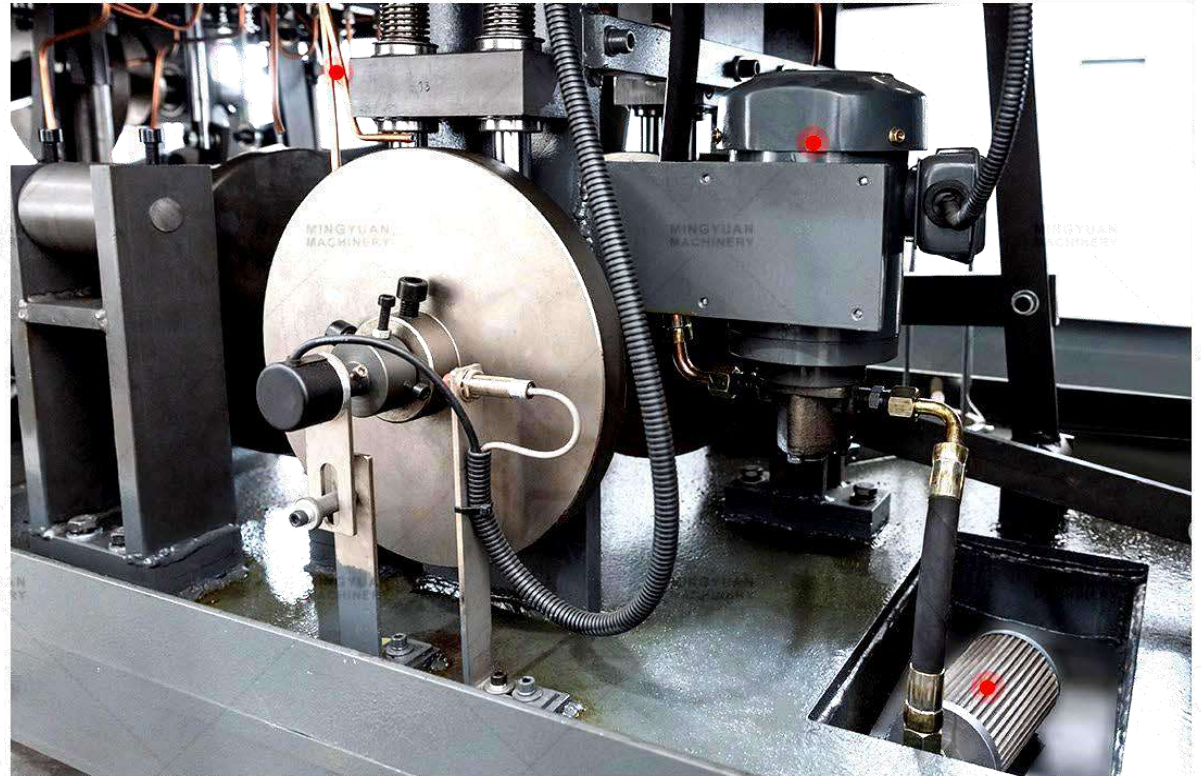

COPPER PIPE



OIL MOTOR

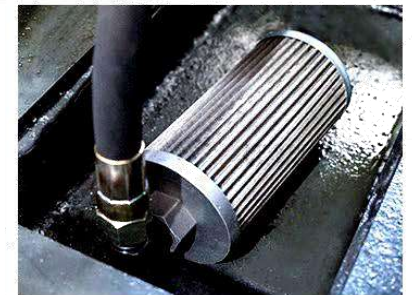

FILTER



Safeway Technologies Ltd.

Technology for moving forward...

Single Main Shaft

All Cams building on Main shaft which keep sure machine running stable and spare without out of location

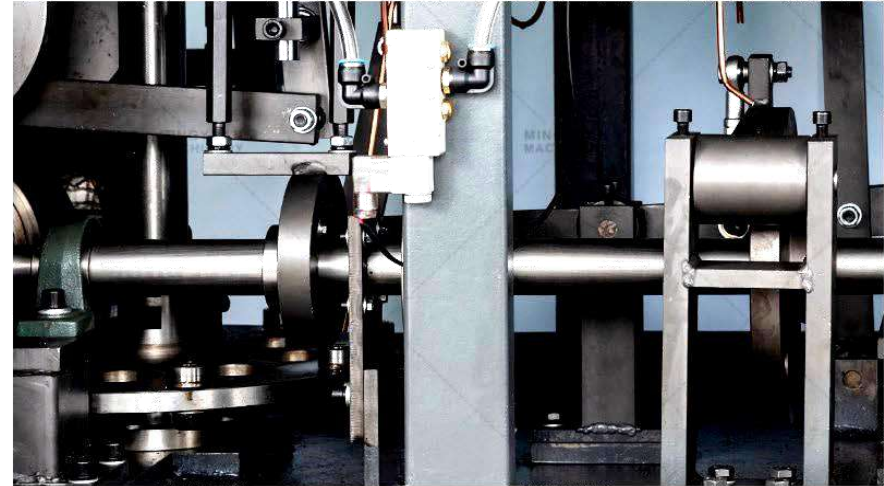

Robot Hand

Catch and remove bowls easily



Safeway Technologies Ltd.

Technology for moving forward...

Free Spare Parts And Tool Box

The operating tools are good quality, durable, sturdy and long service life.
we supply more replaceable parts to client to replace the broken spare parts and help client save money and time to buy it



FREE TOOLS



REPLACEABLE PARTS

